

VISION INSTALLATION STEPS

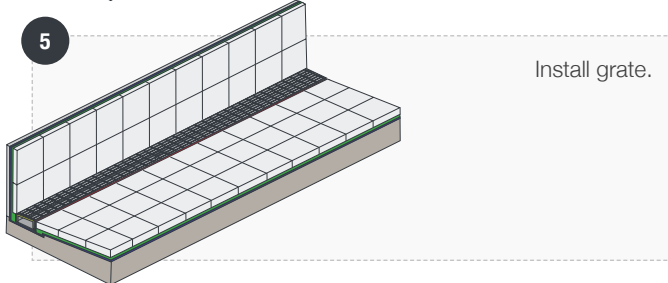

For more information please contact us:
www.allproof.com

DETAILS

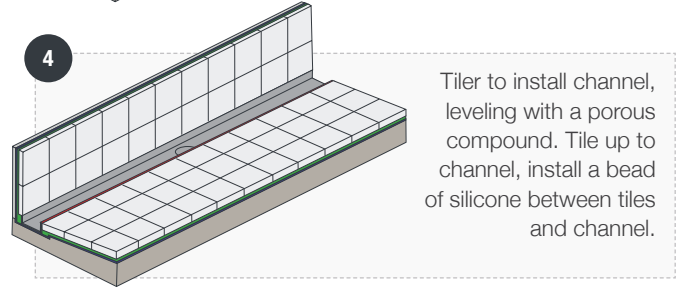
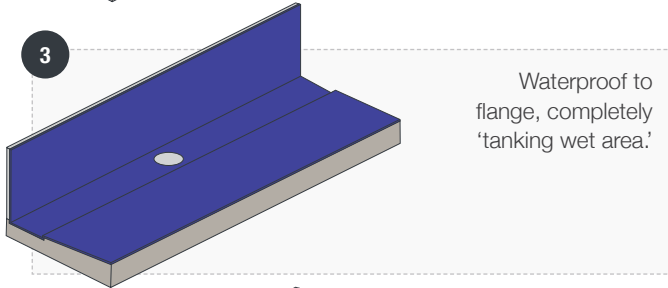
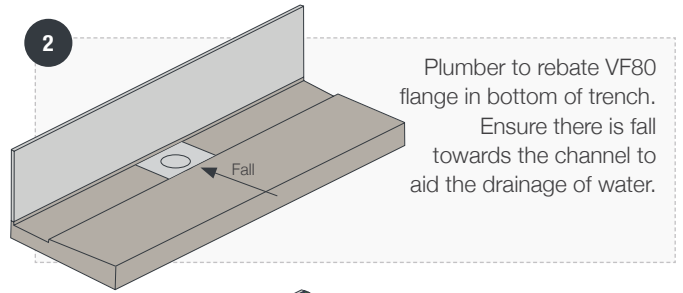
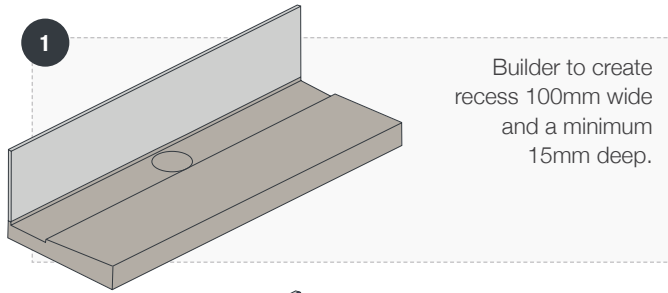
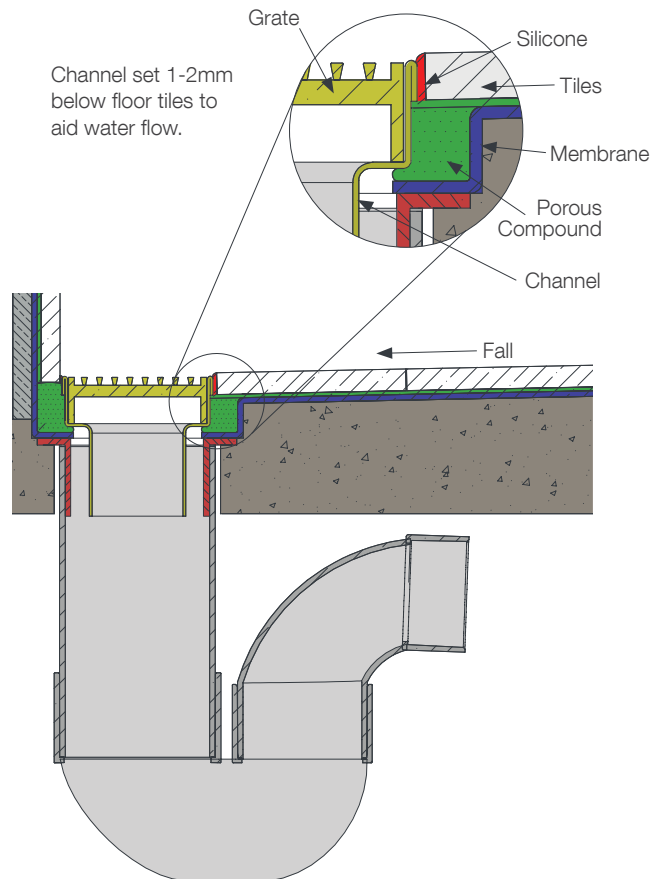
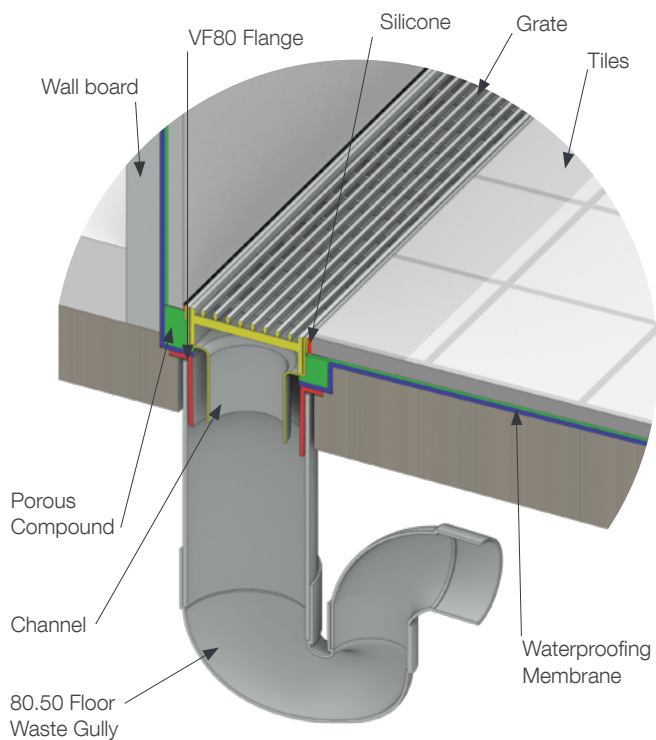

Installation instructions in regards to waterproofing and construction are indicative only. Please refer to your qualified waterproofer and builder to ensure you are adhering to current industry best practise and compliance regulations.